

Clear Ink

Using clear ink will enhance your design

Clear ink will give a more beautiful glossy finish to realize highly value-added enhanced design. By outputting clear ink and color ink at the same time, the productivity will not be affected during printing. Our new technology "MCC" has cleared off the surface dust contamination on the installation site when using clear ink.

*MCC = Mimaki Clear Control

A glossy touch can be added with clear ink even on a part of an image as well as entirely on the whole surface.

Printing with a partial glossy touch

Using clear ink partially will add a highly appealing glossy touch on your print. Partial glossy printing will make food look much fresher and add an extra touch of class to your print.



Glossy printing on the whole surface

Using clear ink entirely will make your print exclusively luxurious. Glossy printing on the whole surface opens the door to really appealing sign and graphic making.

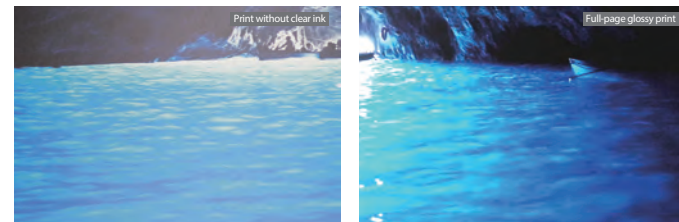

High Quality Print

MAPS2: Mask pattern that works to effectively reduce banding

MAPS2(*) is equipped to effectively curb banding. Printing applies ink while controlling the dot density to add a gradational tone effect, which works to make banding less visible. The normal mask pattern is also available, so you can select an optimal pattern that matches with the particular material and application.

*MAPS2 = Mimaki Advanced Pass System 2

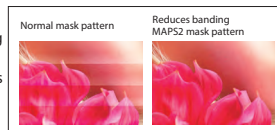

Smooth and beautiful color gradations are made available by Mimaki's original head control technology

Variable drops function provides 3 different drop sizes at once. It produces smooth and natural gradation, without granular appearance even in the 4-color mode.

Advantages of variable dot printing most apparent in expressivity of paler colors and color gradations

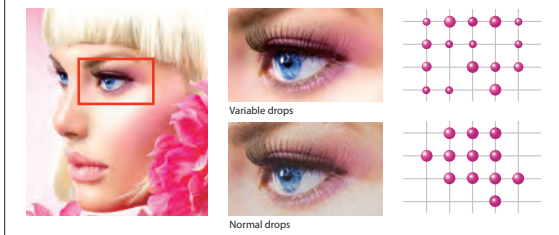

The perfect UV ink for each material and application

LUS-150 provides a flexible ink film that is resistant to cracking once it cured
LH-100 provides a hard ink film that is impervious to scratches once it cured
Choose the perfect UV ink that matches with the particular material and application.

Type	Flexible, quick-drying UV ink	LUS-150	Hard, high-color-density UV ink	LH-100
Color		C M Y K + W	C M Y K + W	
Characteristics	Newly developed UV curable ink with 1.5 times the flexibility and lowered costs. The dried ink film is resistant to cracking even at secondary processing, leading to less wastage in the print result.		Advanced UV curable ink produces a hard ink film that is highly resistant to scratches and chemicals and grants excellent color effects and color reproducibility. Perfect for applications that require no secondary processing such as bending, twisting, etc.	
Flexibility		○		X

* LUS = LED UV Stretchable ink
* The amount of flexibility exhibited by LUS-150 may differ depending on the texture of the print media used. Try out the ink on a test page before proceeding with a full print job.

Print Speed

Print up to 8 sheets of 4x8 panel (1,220mmx2,440mm) per hour

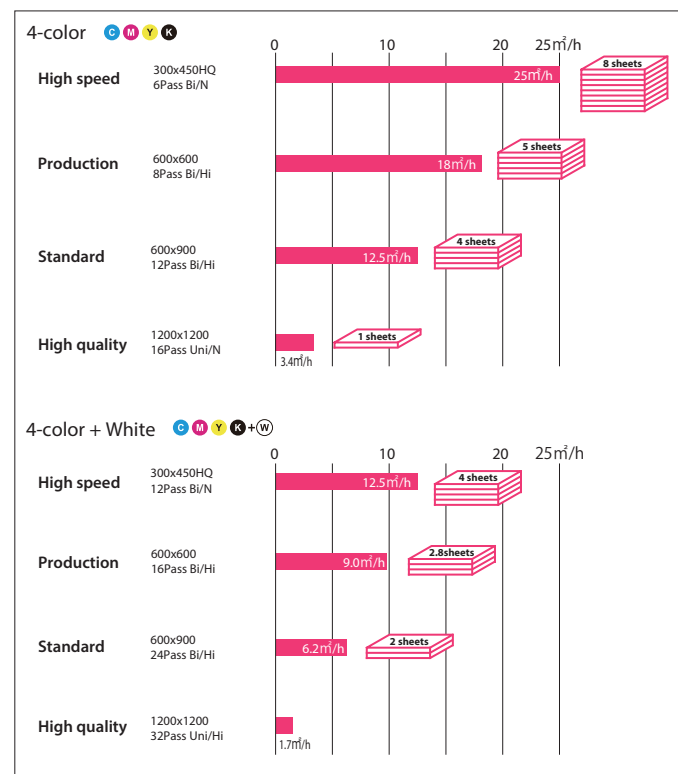

Easy Maintenance

MCT: Mimaki Circulation Technology for White Ink

MCT to effectively avoid the settling of white pigment in the ink lines by regularly circulating white ink is standard equipment. It prevents any print troubles and enables stable output from the startup time. In addition, MCT contributes to reduction of ink waste, thereby supporting environmentally and economically friendly applications.

*MCT works only with white ink.
(MCT = Mimaki Circulation Technology)

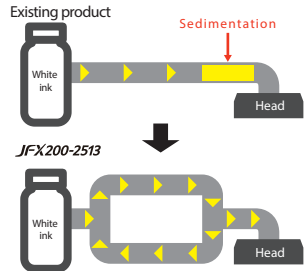

Nozzle Recovery Function for continuous operation

When print troubles occurred due to clogged nozzle and even the nozzle cleaning does not work, the conventional printer have to stop printing and wait for the arrival of service person. With Nozzle Recovery Function, the continuous printing is possible by recovering the image quality without slowing down the speed even if a nozzle is removed or taken offline.

*Recoverability of Nozzle Recovery Function is limited.

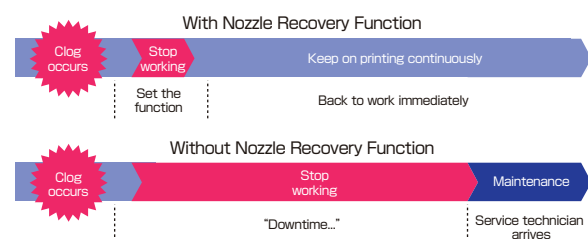

The newly developed software RIP with user-friendly operation and high functionality

RasterLink 6

It would mean nothing to provide high-performance software with a variety of useful functions if the software itself is too difficult and complicated to use... The newly developed RasterLink software was designed to be extremely user-friendly with this idea in mind. With a wide variety of newly added features, RIP software, software for people of all ages and backgrounds, now encompasses a perfect package with all of the features needed to reproduce beautiful full-color finishes in high definition with the easiest set of controls to use to navigate with!!

Specifications

Item	Specifications
Head	On-demand Piezo head (Array of 2 heads stagger)
Diagram resolution	300, 450, 600, 900, 1,200dpi
Ink	Type
	Ink supply system
Media	Dimensions (WxD)
	Height
	Weight
Media absorption	Absorption fixed through use of a vacuum
Range accuracy	Absolute accuracy
	Reproducibility
UV device	LED-UV system
Interface	USB2.0
Safety standard	VCCI class A, CE Marking, CB Report, UL (U.S. safety organization), RoHS directive, UL 60950-1, FCC class A
Input power supply	Single phase, 200 V AC-240 V AC, 50 Hz/60 Hz, up to 12 A
Power consumption	Temperature
	Relative humidity
	Accuracy maintained temperature
	Temperature gradient
Dimensions (WxDxH)	Dust
	Weight

*1 MCT works only with white ink. *2 The standard service life times listed are estimates and do not guarantee the operation.

Supplies

Item	Color	Item No.	Remarks
LUS-150	Cyan	LUS15-C-BA	
	Magenta	LUS15-M-BA	
	Yellow	LUS15-Y-BA	
	Black	LUS15-K-BA	
	White	LUS15-W-BA	
LH-100	Cyan	LH100-C-BA	Volume per bottle: 1 L
	Magenta	LH100-M-BA	
	Yellow	LH100-Y-BA	
	Black	LH100-K-BA	
	White	LH100-W-BA	
Tungsten replacement needle for ionizer	SPA-0208	4 pcs	
Air filter kit	SPA-0209	10 sets	

* Ink and inkjet primer are sold in 1-L bottle. Replace it with the old bottle in the ink station when needed.
* The amount of flexibility exhibited by LUS-150 ink may differ depending on the texture of the print media used.
* Try out the ink on a test page before proceeding with a full print job.
* Printing with LH-100 may not allow the full speed capabilities of the printer to be utilized.

Optional Accessories

Item	Item No.	Remarks
Ionizer kit	OPT-J0342	Static eliminator kit
Vacuum unit (φ 3 mm x 200 mm (φ 0.1 in. x 7.9 in.))	OPT-J0216	Three-phase, 200 V-240 V, 30 A, 3.4 kW
Vacuum unit (φ 1 mm x 200 mm (φ 0.04 in. x 7.9 in.))	OPT-J0217	Single-phase, 200 V-240 V, 30 A, 1.9 kW
Vacuum unit (φ 3 mm x 400 mm (φ 0.1 in. x 15.7 in.))	OPT-J0232	Three-phase, 380 V-480 V, 20 A, 3.4 kW
Optional blower connector kit	OPT-J0330	On sale in May 2014

* If the vacuum unit that comes supplied with the printer does not have enough suction power, please purchase a different vacuum unit with optional settings.
* The optional blower connector kit (OPT-J0330) sold separately is needed to connect a vacuum unit with optional settings to the JFX200-2513.
* Vacuum units also require their own power supply line separate from that for the printer itself.

Some of the samples in this catalogue are artificial renderings. Specifications, design and dimensions stated in this catalogue may be subject to change without notice (for technical improvements, etc.). The corporate names and merchandise names written on this catalogue are the trademark or registered trademark of the respective corporations. Inkjet printers print using extremely fine dots, so colors may vary slightly after replacement of the printing heads. Also note that if using multiple printer units, colors could vary slightly from one unit to other unit due to slight individual differences.



MIMAKI ENGINEERING CO., LTD.
2182-3 Shigeno-otsu, Tomi-city, Nagano 389-0512, Japan
Tel: +81-268-78-2288
trading@mimaki.jp www.mimaki.co.jp

MIMAKI USA, INC.
150 Satellite Boulevard, suite A, Suwanee, Georgia 30024, U.S.A
Atlanta +1-888-530-3988 Boston +1-888-530-3986
Los Angeles +1-888-530-3987 Chicago +1-888-530-3985
www.mimakiusa.com

MIMAKI EUROPE B.V.
Stammerdijk 7E, 1112 AA Diemen, The Netherlands
Tel: +31-20-4627-640
info@mimaki-europe.com
www.mimaki-europe.com @MimakiEurope

D820279-02

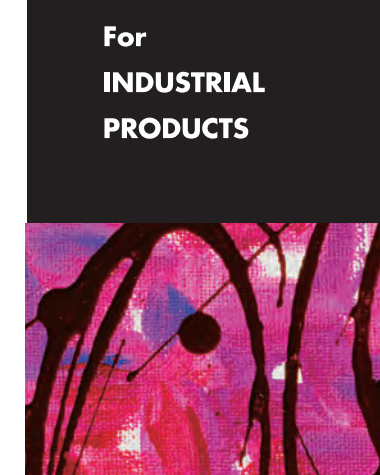

OPEN UP!

Introduction of new entry-model flatbed printer expanding the possibilities of printing business.

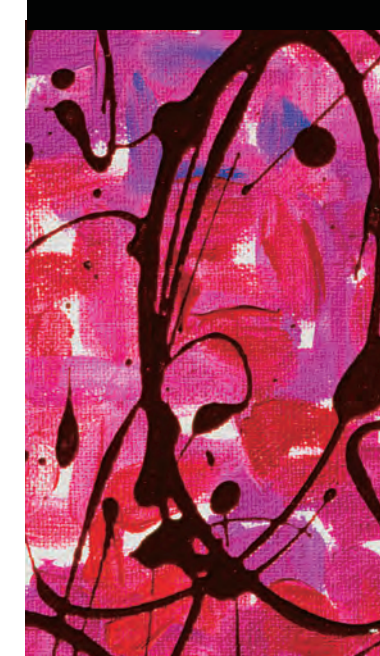

High-performance entry-level model

Developed using Mimaki engineering knowhow and technology, the JFX200-2513 is an entry-level model printer that nevertheless equipped with all the necessary performance, product quality, ease of use, and environmental friendliness required of a flatbed printer.



For INDUSTRIAL PRODUCTS

JFX200-2513



Environmentally friendly LED-UV curing unit



The LED-UV curing unit has an exceptionally long life and lower power consumption. With its low heat output, it can be used with print media susceptible to problems with thermal deformation or color changes. Producing very few VOCs and very little odor, it is both environmentally friendly and user-friendly and works well in indoor applications such as restaurants. It also produces no potentially destructive ozone during the printing process, which dramatically lessens any potential load on the environment.



Perfect size for installation and usage

Can be used to print 4x8 panel boards* that are commonly used in the marketplace. Comes in a compact size for easy installation and provides excellent user-friendliness even with such high functionality.

*1,220mmx2,440mm

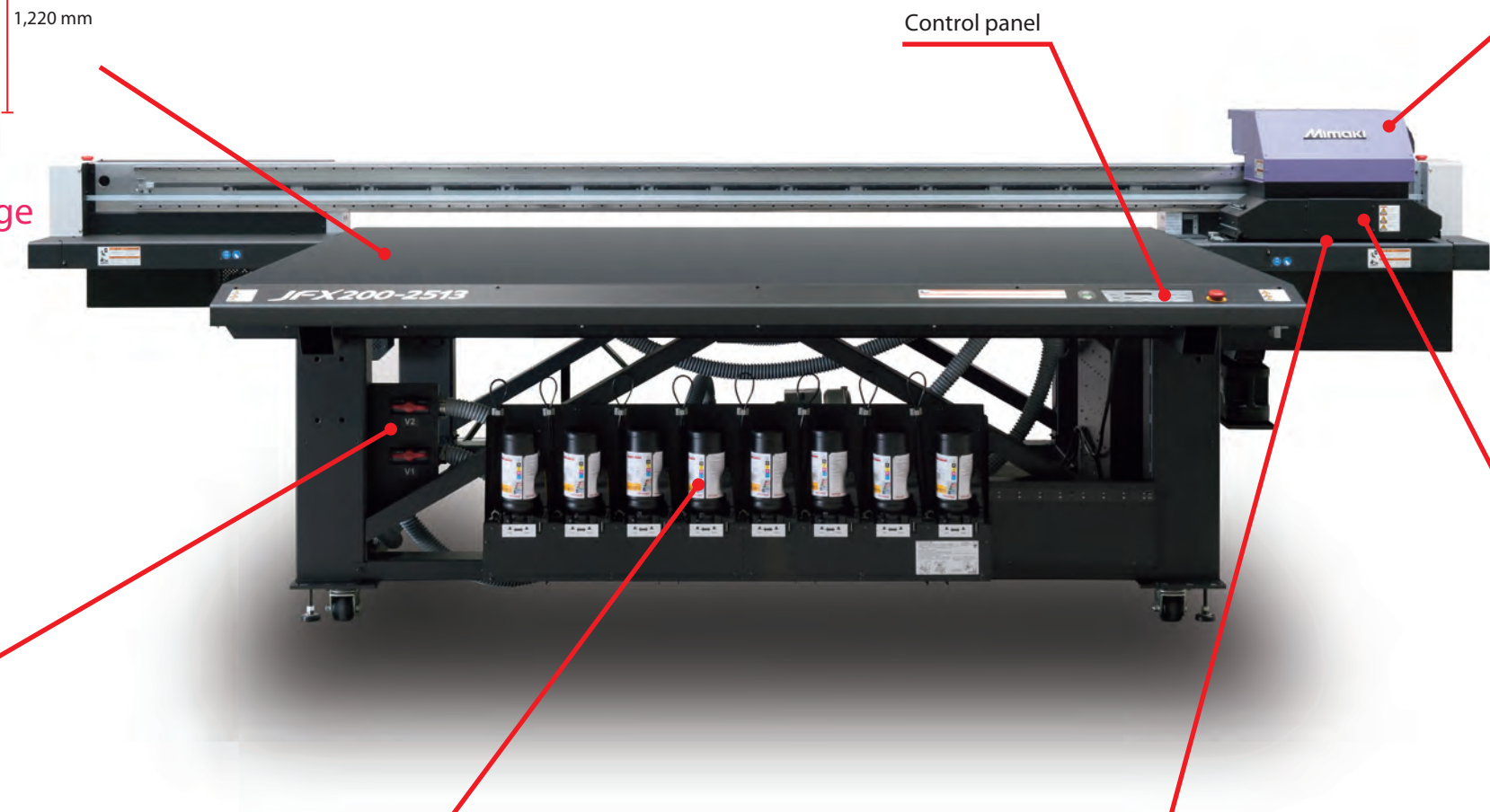

Control panel

Direct-to-media printing onto thick media



Display case



Indoor advertisement



Outdoor advertisement

Printing onto media up to 50 mm (1.97 in.) thick, high weather and friction resistance, printing onto media with special shapes... The JFX200-2513 produces unparalleled results all in high definition. Works to expand customer business by accommodating a wide variety of needs and requirements.



Vacuum unit/suction valve

The vacuum can be turned ON/OFF quite easily and quickly from the control panel. The control panel can also be used to control two separate partitions in the X-direction of the suction area. The suction valve on the front of the printer enables the area to be controlled rather easily.



Ink supply unit

With the newly developed ink supply unit, 1-L bottles of ink can be inserted into the system and used as is. Ink bottles can be inserted quickly and easily from the front of the printer, speeding up the replacement process.



Compatible with print media up to 50 mm (1.97 in.) thick

Direct-to-media printing onto thick media

Images can be printed out not only onto regular paper media but also directly onto thick media. Works with media up to 50 mm (1.97 in.) thick to support expansion into a wide variety of print business applications.



Second layer (Full color)

First layer (White)

Two-layer print function

Two-layer printing of separate white and full color layers is possible at the same time. A coating of white ink can be applied evenly at high accuracy to really bring rich and vibrant colors to life even more beautifully with transparent print media.